



PLACCHE



OLIVARI 

Dal 1911 Olivari realizza maniglie in Italia,
all'interno dei propri stabilimenti,
dove si svolge l'intero ciclo produttivo.
Partendo da barre in ottone, le maniglie vengono
stampate, lavorate, smerigliate, lucidate,
cromate e marchiate al laser.
Olivari ha ottenuto le certificazioni
ISO 9001 e ISO 14001
e si avvale delle tecnologie più evolute,
ma ha mantenuto tutta la sapienza artigianale
accumulata in cento anni di storia.

Since 1911 Olivari has been manufacturing handles
at its own factories in Italy
where the entire production process takes place.
Starting with brass billets, the handles are forged, milled,
polished, buffed, chrome-plated and hallmarked with a laser.
Olivari has attained ISO 9001
and ISO 14001 certifications.
Though it uses the most advanced technology,
Olivari preserves all the artisanal wisdom
it has accumulated in 100 years of history.

OLIVARI 

PLACCA ORIZZONTALE BASSA

adatta per tutte le maniglie

LOW HORIZONTAL PLATE

suitable to every handle

PLACCA ORIZZONTALE BASSA

La placca orizzontale bassa è stata ideata come alternativa alla rosetta, per svolgere una duplice funzione.

Innanzitutto una funzione estetica: essendo una sorta di sfondo, di proiezione della maniglia, rende l'insieme un tutt'uno integrato, con forte segnalazione e connotazione.

In secondo luogo una funzione tecnica:

la sua estensione dietro la maniglia impedisce di toccare la porta e quindi evita il rischio di urtarla e rovinarla.

Per consentire di utilizzare la placca orizzontale con tutte le maniglie del catalogo, sono state realizzate due versioni: una rettangolare e una ovale.

Entrambe sono dotate di molla di ritorno molto robusta e di posizione di arresto orizzontale, al fine di riportare sempre in corretta posizione la maniglia dopo il suo utilizzo.

Testate secondo la prova di resistenza (norma DIN EN 1906), hanno superato i 200.000 cicli, risultando appartenere alla classe 4, cioè adatte agli utilizzi gravosi. Di fatto poi la prova è stata prolungata fino a 1.000.000 di cicli, che sono stati agevolmente superati. Entrambe le placche sono disponibili in tutte le finiture previste a catalogo.

LOW HORIZONTAL PLATE

The low horizontal plate was designed as an alternative to the rosette, to perform a dual function.

First of all, an aesthetic function: being a sort of backdrop, an extension of the door handle, it creates the effect of one whole integrated piece, with strong expression and substance.

Secondly, a technical function: its presence prevents the door handle from touching the door and therefore avoids the risk of hitting and damaging it.

With the aim of allowing the use of the horizontal plate with all the door handles in the catalogue, two versions are made: a rectangular one and an oval one.

Both are equipped with a very strong return spring and a horizontal stop position, in order to bring the door-handle always back to its correct position after use.

Tested according to the resistance test (DIN EN 1906), they exceeded 200,000 cycles, resulting in the 4th grade of classification namely suitable to heavy use. In fact, the test was extended up to 1,000,000 cycles, which were easily exceeded. Both versions are available in all the finishes listed in the catalogue.







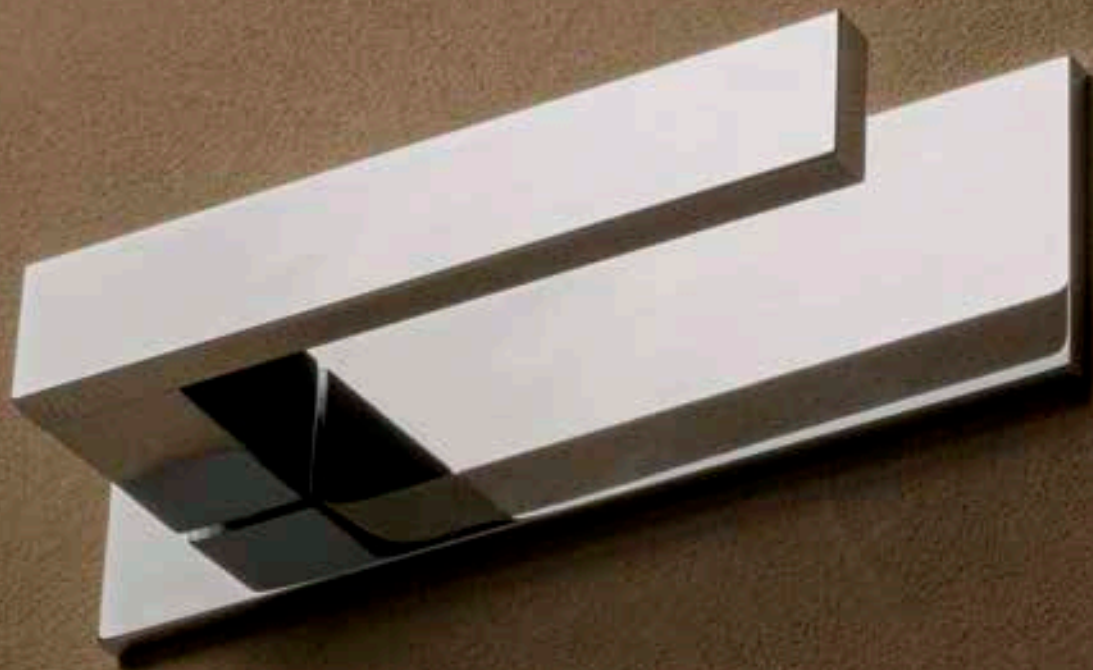





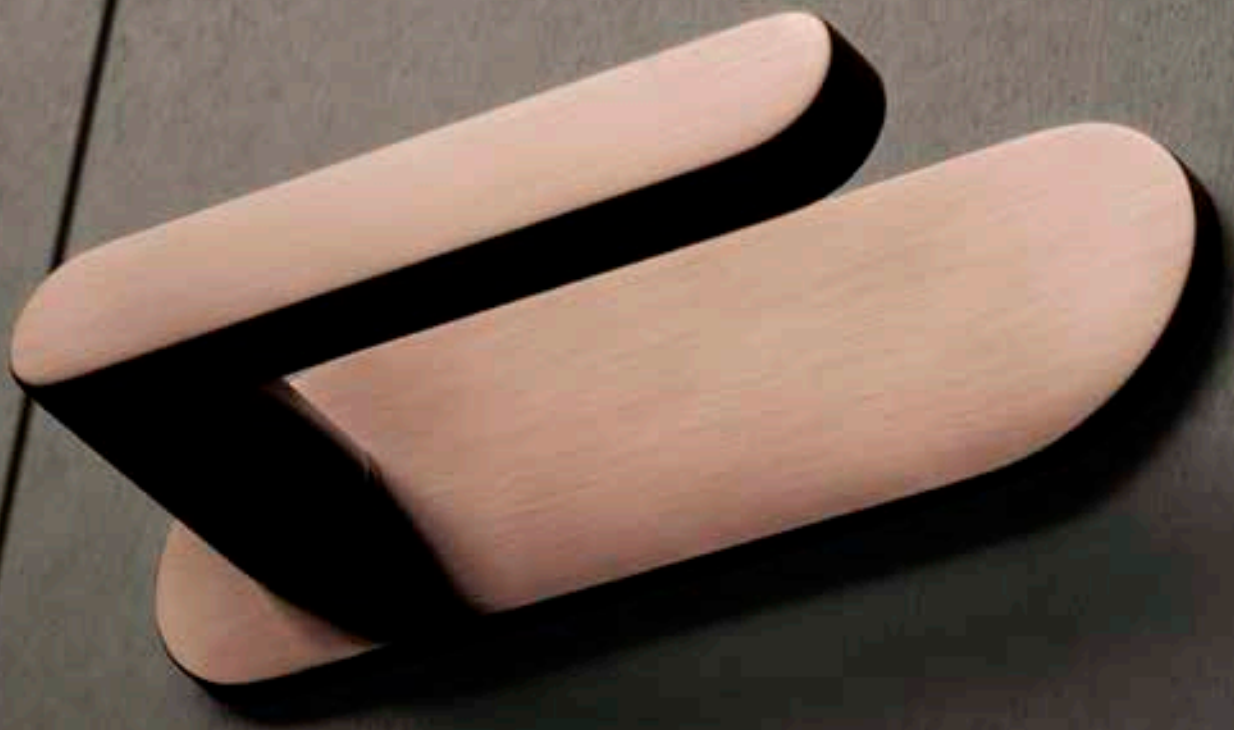









Finiture/Finishing



CR Cromo lucido/Bright chrome



ZL SuperOro lucido/
SuperGold bright



NL SuperNichel lucido/
SuperNickel bright



RS SuperRame satinato/
SuperCopper satin

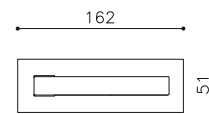

CO Cromo satinato/Satin chrome



TS SuperOro satinato/
SuperGold satin



NS SuperNichel satinato/
SuperNickel satin



DS SuperBronzo satinato/
SuperBronze satin

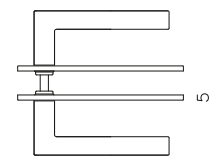

IS SuperInox satinato/
SuperStainlessSteel satin



US SuperAntracite satinato/
SuperAnthracite satin



CR Cromo lucido/Bright chrome



ZL SuperOro lucido/
SuperGold bright



NL SuperNichel lucido/
SuperNickel bright



RS SuperRame satinato/
SuperCopper satin

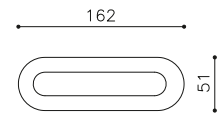

CO Cromo satinato/Satin chrome



TS SuperOro satinato/
SuperGold satin



NS SuperNichel satinato/
SuperNickel satin



DS SuperBronzo satinato/
SuperBronze satin

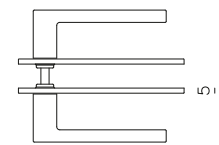

IS SuperInox satinato/
SuperStainlessSteel satin



US SuperAntracite satinato/
SuperAnthracite satin

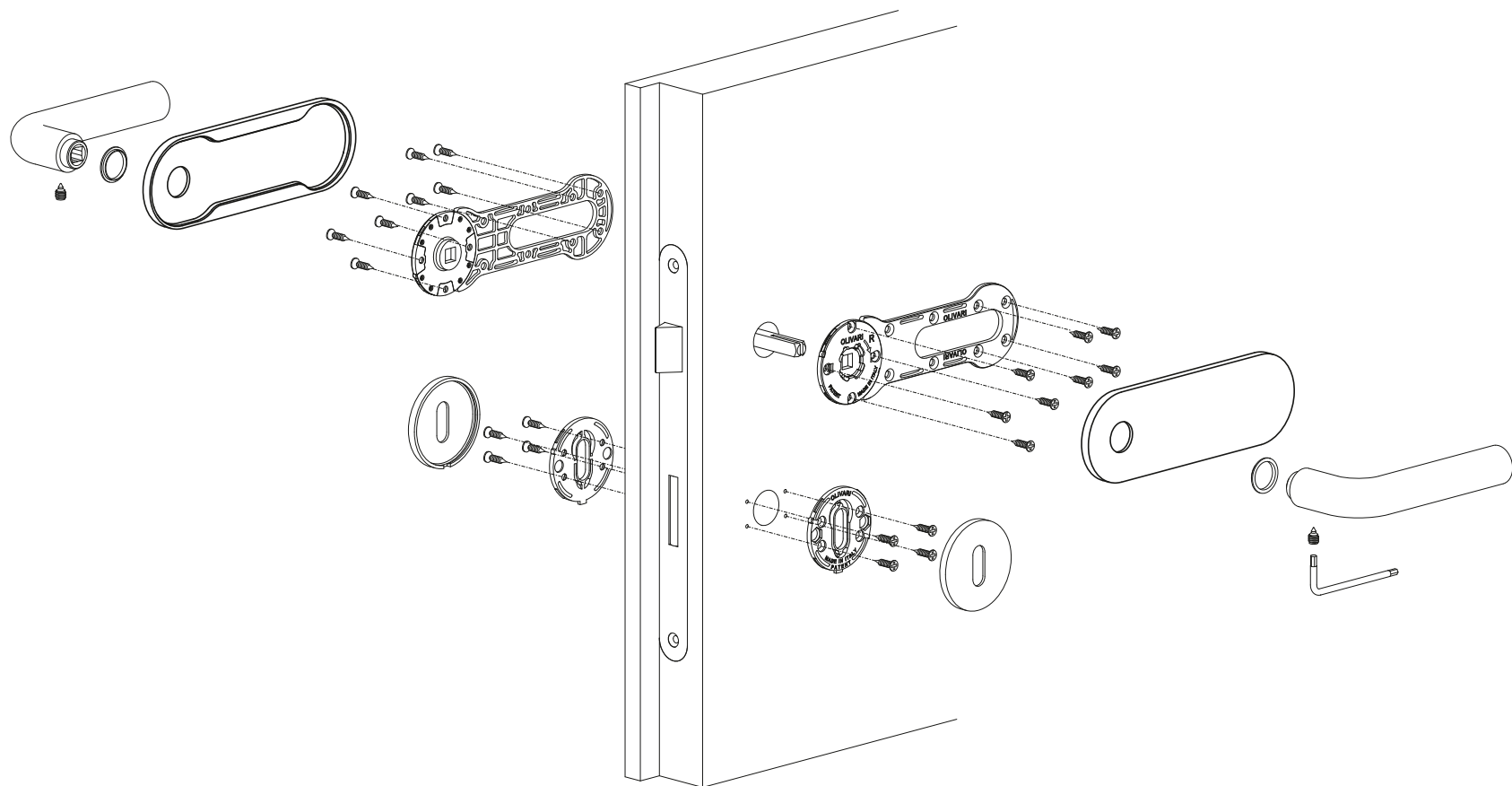

Il catalogo è soggetto ad aggiornamenti. Ci riserviamo di apportare qualsiasi modifica ai prodotti e di eliminarli dalla produzione, senza obbligo di preavviso. Dati, misure o schemi hanno solamente carattere informativo e non sono vincolanti. Olivari declina qualsiasi responsabilità per eventuali refusi e/o errori presenti nel catalogo. Tutti i diritti riservati © OLIVARI B. s.p.a. I prodotti OLIVARI sono tutelati da brevetto in Europa e in molti paesi extra UE. Al fine di evitare contraffazioni, marchiamo al laser tutte le maniglie sia con il logo OLIVARI sulla leva che con il codice identificativo del lotto e la data di produzione sul collarino. Questa marcatura indelebile, certifica che il prodotto è realizzato in ambito ISO 9001 e ne consente la tracciabilità. Invitiamo i clienti a diffidare da prodotti "tipo OLIVARI" e ad acquistare solo prodotti originali "OLIVARI".

We reserve the right to modify and discontinue any products, without prior notice. Olivari declines all responsibility for any misprints and / or errors in the catalog. All rights reserved © Olivari B. s.p.a. OLIVARI products are registered and patented in Europe and many countries extra UE. In order to avoid counterfeits, we laser-mark all the door handles both with the OLIVARI logo on the lever and with the identification code of the lot and the date of production on the neck. This indelible marking, certifies that the product is made in ISO 9001 and allows traceability. We invite customers to beware of "OLIVARI type" products and to buy only "OLIVARI" original products.

Concept and graphic

Marco Strina

Photo

Sauro Sorana

Pre press

Up studio_Milano

Printed in Italy

Galli Thierry_Milano 2019



Olivari B. spa

Via Giacomo Matteotti, 140
28021 Borgomanero NO Italy

T +39 0322 835080

F +39 0322 846484

olivari@olivari.it

www.olivari.it

Questo catalogo è stato stampato su carta Sappi Magno Satin certificata FSC, prodotta con cellulosa proveniente da foreste gestite in maniera responsabile.

L'energia necessaria per la stampa è stata prodotta da un impianto fotovoltaico.

Il contributo all'ambiente è il seguente: CO₂ non immessa in atmosfera 79.645 kg/year, petrolio risparmiato 42.063 l/year, alberi equivalenti 159 trees/year.

This catalog was printed on paper Sappi Magno Satin FSC certified, produced with cellulose coming from responsibly managed forests.

The energy for printing was totally produced by a photovoltaic system. The contribution to the environment is the following: CO₂ not released into the atmosphere 79.645 kg / year, oil saved 42.063 l / year, trees equivalent 159 trees / year.





PLATES



olivari.it